



BL1.8/35-19

Specifications

Part Number	B190535	HH'	-14.635mm
Focal Length	35mm	Mount	C-Mount
Image Circle	19.2mm	MaxD	Φ40.4
Max. F#	F1.8	Filter	M34×0.5
Magnification	0.0-0.25	Σd	40.45mm
Spectrum	420nm - 680nm	A'	-3.36mm-9.69mm
Working Distance	140mm-∞	A'f	5.22mm-17.55mm
Resolution	2.74 μm		

Mechanical Drawing

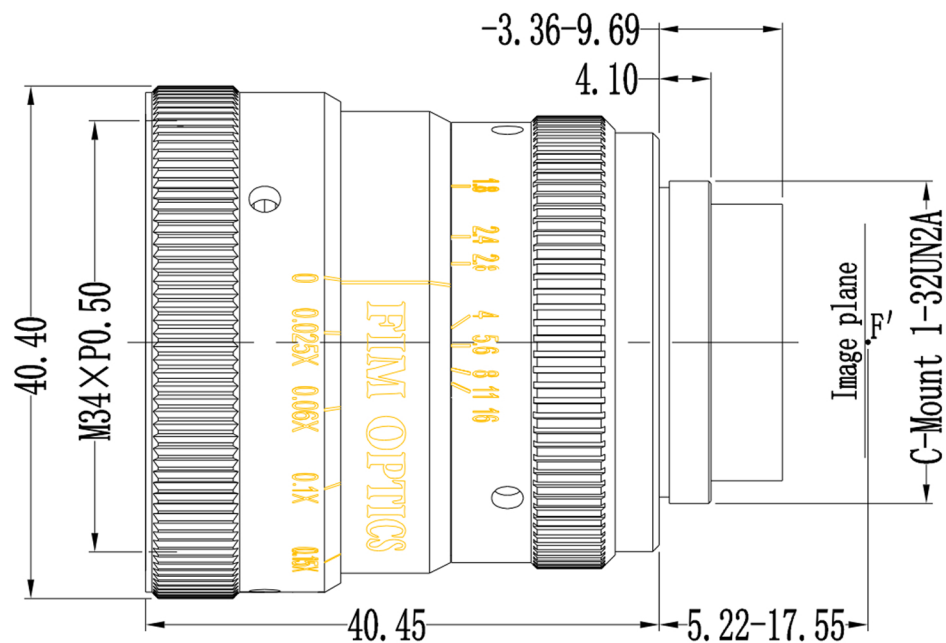

Distortion

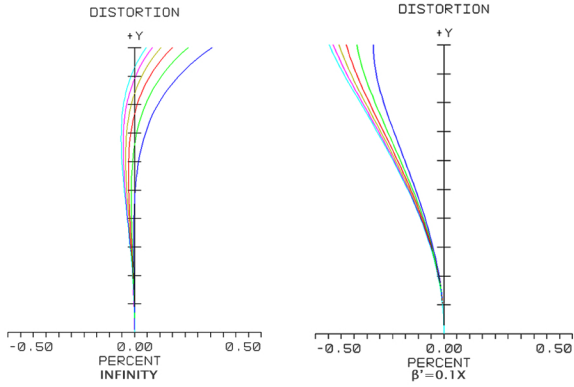

Field Curvature

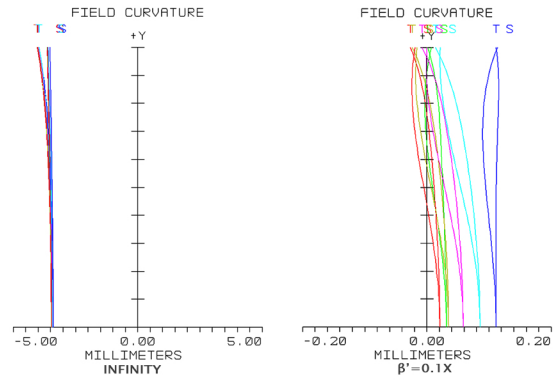

Modulation to Relative Image Height

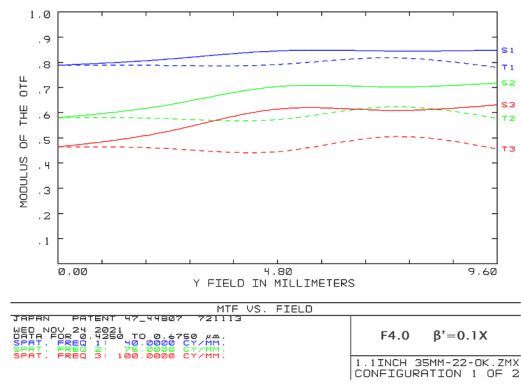
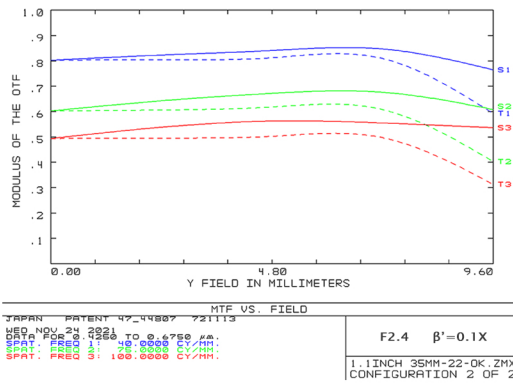

Relative Illumination

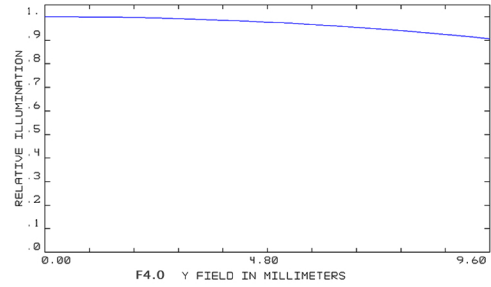
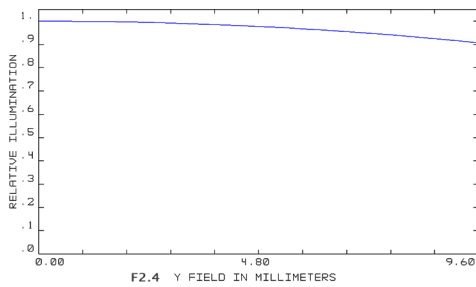

Transmittance

